

更改 REV	設 變 內 容 MODIFICATION	日 期 DATE	修 改 DRAW

NOTE:

1.MATERIAL:
 HOUSING: NYLON UL 94V-0
 CONTACT: PHOSPHOR BRONZE
 PLATING: TIN
 TEMPERATURE: -20°C TO +85°C

2.SPECIFICATION:
 SIZE: 4 TO 60 CIRCUITS
 FOR 0.5mm THICK FFC/FPC.
 VOLTAGE: 50V
 CURRENT: 0.5A
 CONTACT RESISTANCE: 20m Ω MAX.
 DIELECTRIC WITHSTANDING VOLTAGE: 500V AC

DIMENSIONS(mm)

CKT.	Catalog Number	A	B	C
02	FC503-02	8.40	2.00	3.10
03	FC503-03	9.40	3.00	4.10
04	FC503-04	10.40	4.00	5.10
05	FC503-05	11.40	5.00	6.10
06	FC503-06	12.40	6.00	7.10
07	FC503-07	13.40	7.00	8.10
08	FC503-08	14.40	8.00	9.10
09	FC503-09	15.40	9.00	10.10
10	FC503-10	16.40	10.00	11.10
11	FC503-11	17.40	11.00	12.10
12	FC503-12	18.40	12.00	13.10
13	FC503-13	19.40	13.00	14.10
14	FC503-14	20.40	14.00	15.10
15	FC503-15	21.40	15.00	16.10
16	FC503-16	22.40	16.00	17.10
17	FC503-17	23.40	17.00	18.10
18	FC503-18	24.40	18.00	19.10
19	FC503-19	25.40	19.00	20.10
20	FC503-20	26.40	20.00	21.10
21	FC503-21	27.40	21.00	22.10
22	FC503-22	28.40	22.00	23.10
23	FC503-23	29.40	23.00	24.10
24	FC503-24	30.40	24.00	25.10
25	FC503-25	31.40	25.00	26.10
26	FC503-26	32.40	26.00	27.10
27	FC503-27	33.40	27.00	28.10
28	FC503-28	34.40	28.00	29.10
29	FC503-29	35.40	29.00	30.10

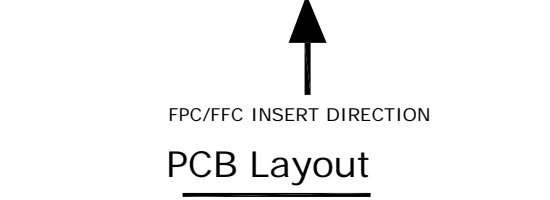
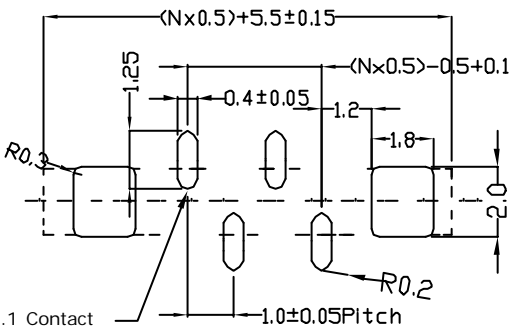
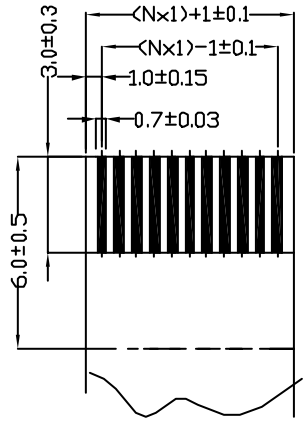
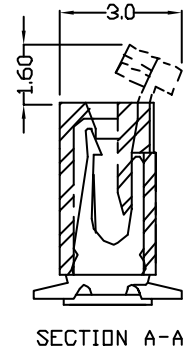
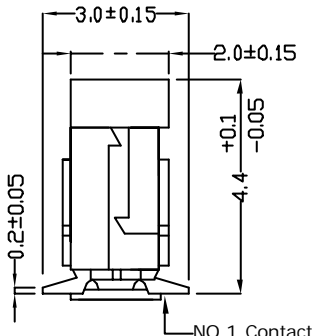
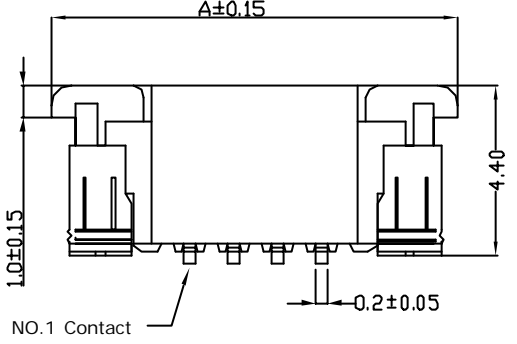
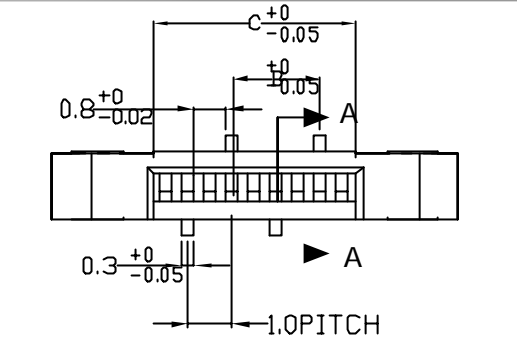

DIMENSION IN mm [Inch]			 康茂股份有限公司 COMMA ELECTRONIC INC.	
TOLERANCE UNLESS OTHERWISE SPECIFIED			名稱 TITLE	CUSTOMER DRAWING
.X±0.3	X.'± 1'	審核 APPROVE	FPC 抽屜立式 P=1.0mm	
.XX±0.20	.X'± 0.5'	核對 CHECK	案號 FILE NO.	圖號 DWG NO.
.XXX±0.100	.XX'± 0.25'	製圖 DRAW	FPS1.0-41XX	FPS1.0-41XX
		圖紙 SIZE	A4	角法 PROJ.
		比例 SCALE	4:1	張數 SHEET
				1 / 1
				更改 REV
				A